

JB SANITARY

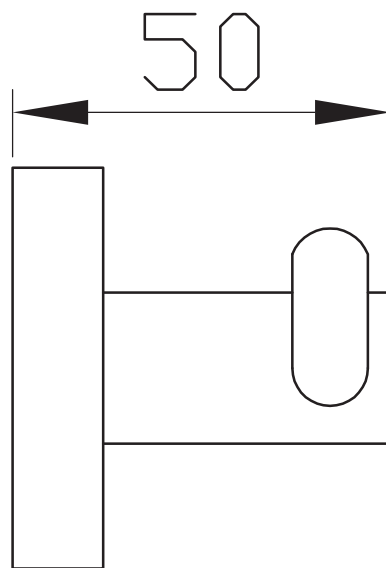
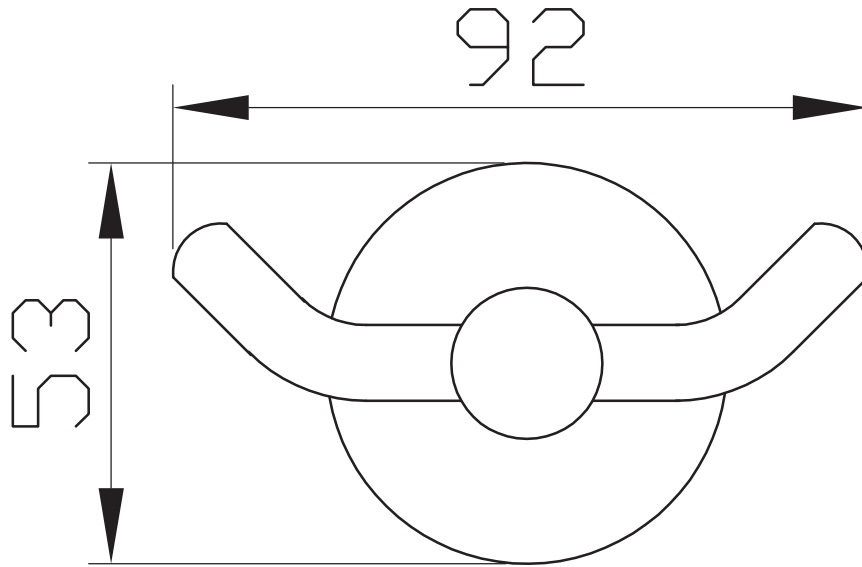

KB01 00